

Analog Devices Welcomes Hittite Microwave Corporation

NO CONTENT ON THE ATTACHED DOCUMENT HAS CHANGED



THIS PAGE INTENTIONALLY LEFT BLANK

Typical Applications

The HMC892LP5E is ideal for:

- Test & Measurement Equipment
- Military RADAR & EW/ECM
- SATCOM & Space
- Industrial & Medical Equipment

Functional Diagram

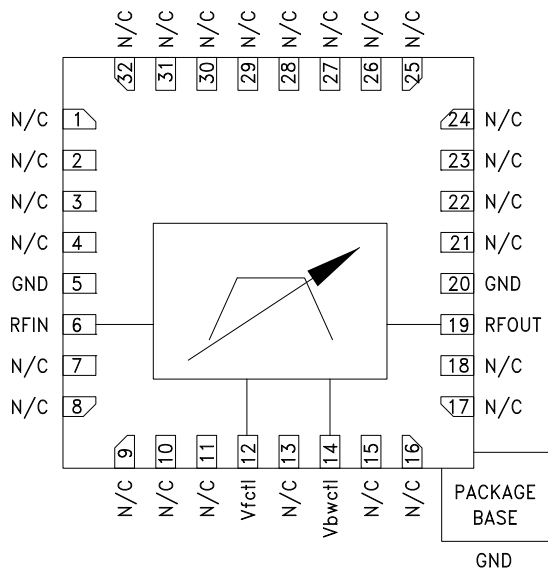

Features

- Fast Tuning Response; 200 ns
- Excellent Wideband Rejection; >30 dB
- Single Chip Replacement for Mechanically Tuned Designs
- 32 Lead 5x5 mm SMT Package

General Description

The HMC893LP5E is a MMIC band pass filter which features a user selectable passband frequency. The 3 dB filter bandwidth is approximately 6.5%. The 20 dB filter bandwidth is approximately 18%. The center frequency can be varied between 4.8 and 9.5 GHz by applying an analog tune voltage between 0 and 14V. This tunable filter can be used as a much smaller alternative to physically large switched filter banks and cavity tuned filters. The HMC893LP5E has excellent microphonics due to the monolithic design, and provides a dynamically adjustable solution in advanced communications applications.

Electrical Specifications, $T_A = +25^\circ\text{C}$, $V_{ctl} = V_{bwctl}$ Unless Otherwise Stated

Parameter	Min.	Typ.	Max.	Units
F_{center} Tuning Range	4.8		9.5	GHz
3 dB Bandwidth		6.5		%
Low Side Rejection Frequency (Rejection >20 dB)		$0.9 \cdot F_{center}$		GHz
High Side Rejection Frequency (Rejection >20 dB)		$1.1 \cdot F_{center}$		GHz
Re-entry Frequency (Rejection <30 dB)		$2.7 \cdot F_{center}$		GHz
3 dB Bandwidth Control (V_{bwctl})		± 3		%
Insertion Loss		10		dB
Return Loss (2 dB Bandwidth)		7		dB
Maximum Input Power for Linear Operation			10	dBm
Frequency Control Voltage (V_{ctl})	0		14	V
Source/Sink Current (I_{ctl})			± 1	mA
Bandwidth Control Voltage (V_{bwctl})	0		14	V
Source/Sink Current (I_{bwctl})			± 1	mA
Residual Phase Noise [1] (1 MHz Offset)		-163		dBc/Hz
F_{center} Drift Rate		-0.75		MHz/ $^\circ\text{C}$
Tuning Characteristics [2] tFULLBAND (0% V_{ctl} to 90% RF)		200		ns

[1] Optimum residual phase noise performance requires the use of a low noise driver circuit.

[2] Tuning speed is dependent on driver circuit. Data measured with a high speed op-amp driver and includes driver slew rate delay.



**FILTER - TUNABLE, BAND PASS SMT
4.8 - 9.5 GHz**

Broadband Insertion Loss vs. Control Voltages, $V_{fctl} = V_{bwctl}$

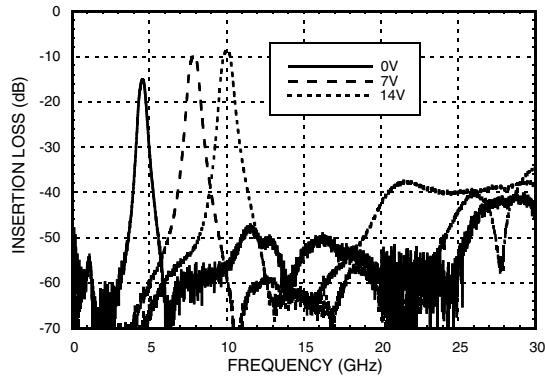

Broadband Return Loss vs. Control Voltages, $V_{fctl} = V_{bwctl}$

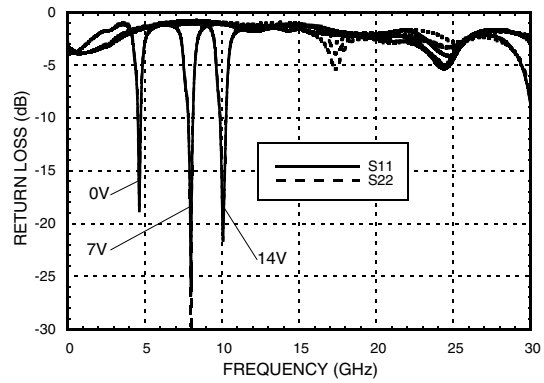

Insertion Loss vs. Control Voltages, $V_{fctl} = V_{bwctl}$

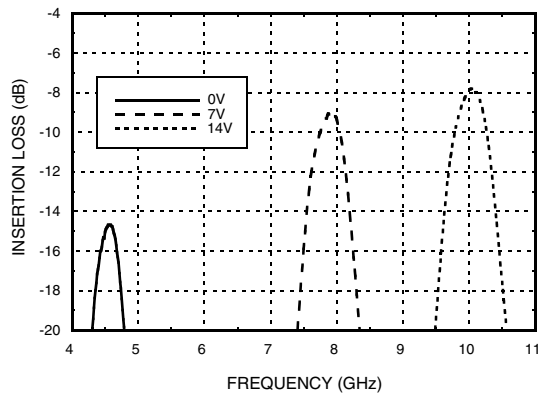

Return Loss vs. Control Voltages, $V_{fctl} = V_{bwctl}$

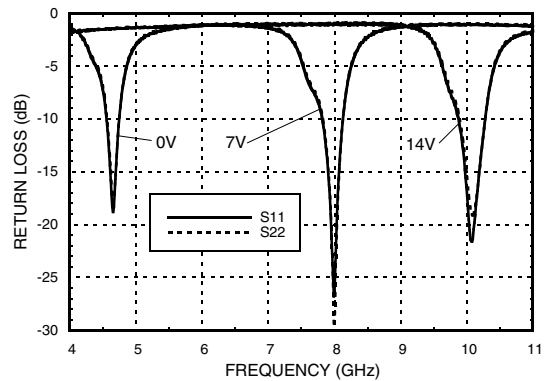

Insertion Loss vs. Temperature, $V_{fctl} = V_{bwctl} = 7V$

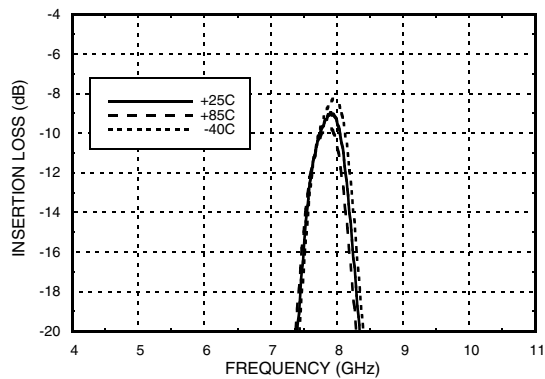

Return Loss vs. Temperature, $V_{fctl} = V_{bwctl} = 7V$

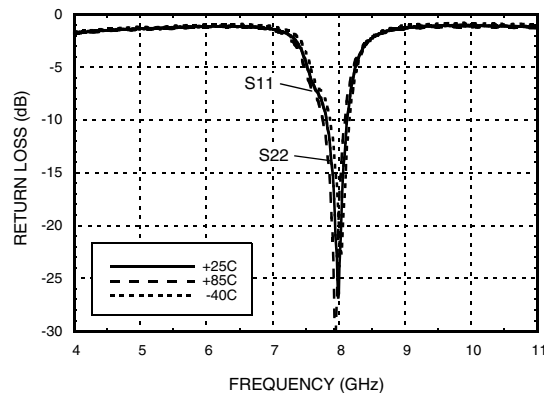

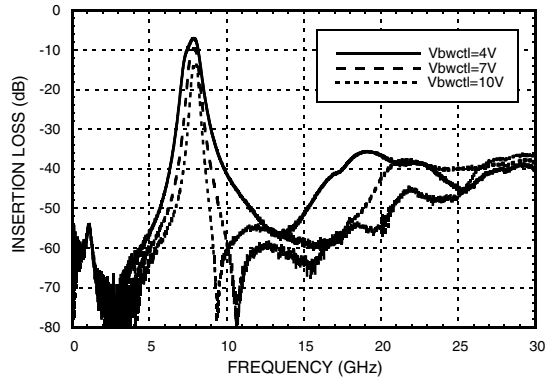
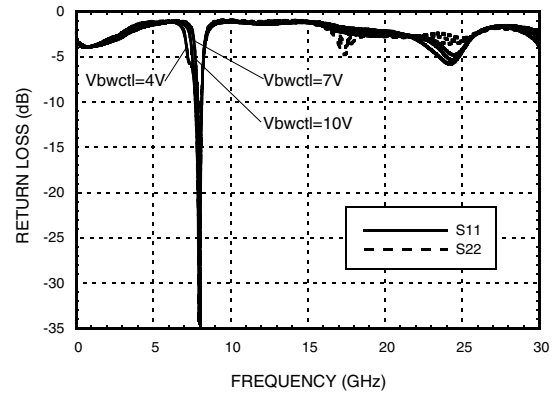
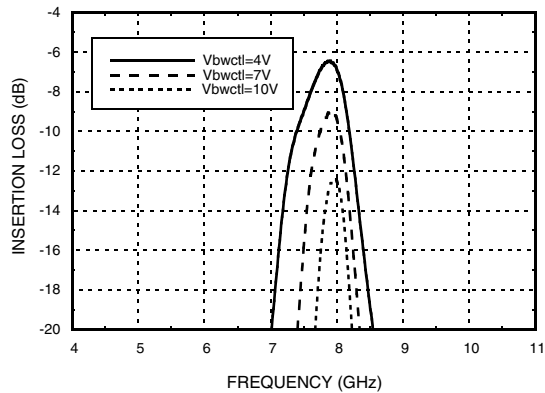
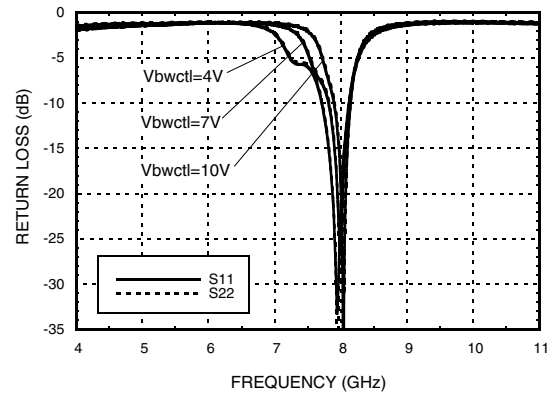
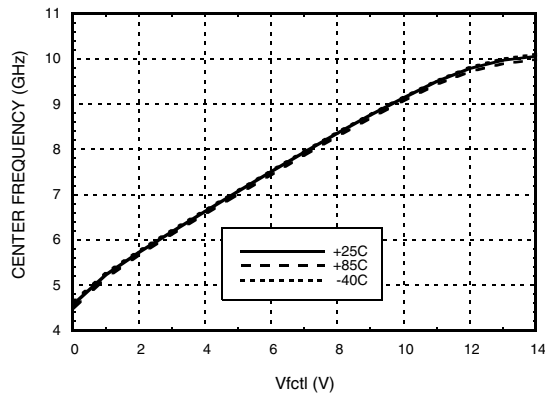
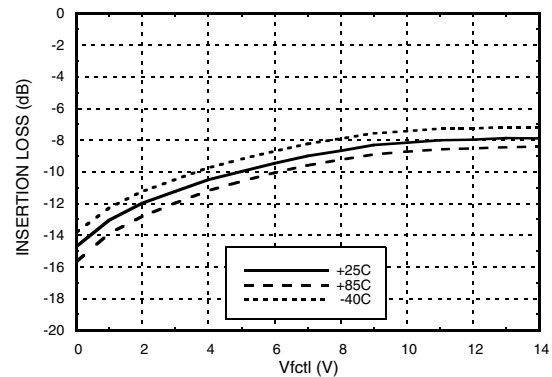
**Broadband Insertion Loss vs.
Vbwctl, Vfctl = 7V**

**Broadband Return Loss vs.
Vbwctl, Vfctl = 7V**

Insertion Loss vs. Vbwctl, Vfctl = 7V

Return Loss vs. Vbwctl, Vfctl = 7V

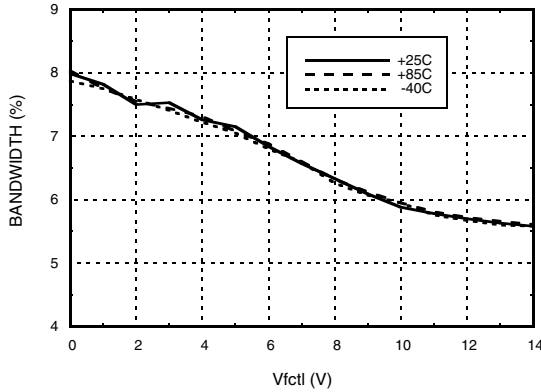
**Center Frequency vs.
Temperature, Vfctl = Vbwctl**

**Insertion Loss vs.
Temperature, Vfctl = Vbwctl**



**FILTER - TUNABLE, BAND PASS SMT
4.8 - 9.5 GHz**

**3 dB Bandwidth vs. Temperature,
Vfctl = Vbwctl**



**Maximum Return Loss in a 2 dB Bandwidth
vs. Temperature, Vfctl = Vbwctl**

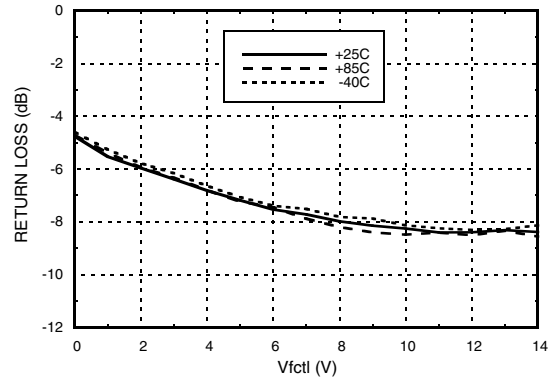

**Low Side Rejection Ratio vs.
Temperature, Vfctl = Vbwctl [1]**

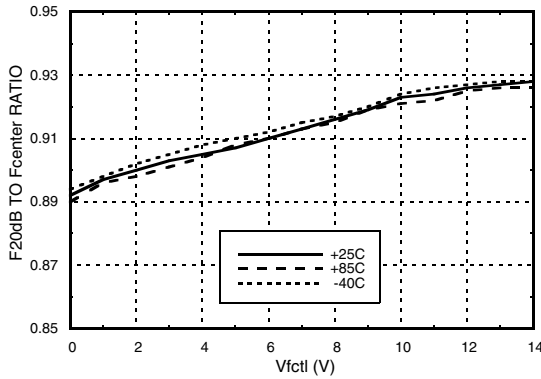

**High Side Rejection Ratio vs.
Temperature, Vfctl = Vbwctl [1]**

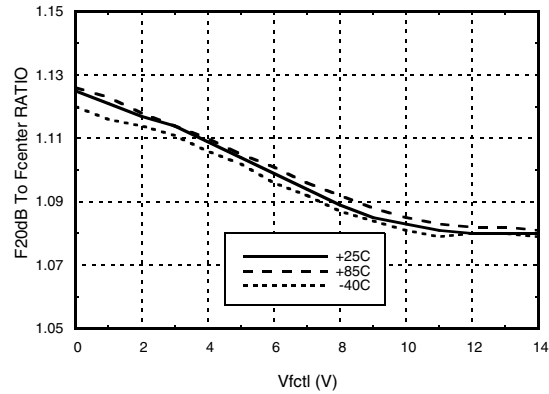

**Tuning Sensitivity vs.
Temperature, Vfctl = Vbwctl**

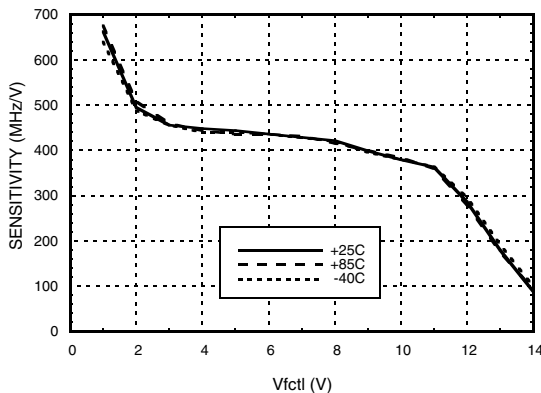

Group Delay

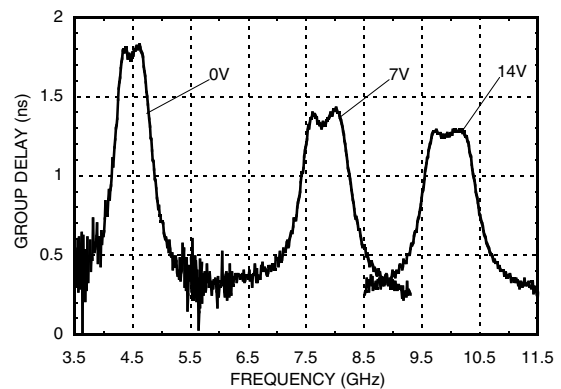

[1] Rejection ratio is defined as the ratio of the frequency at which the relative insertion loss is 20 dB to fcenter



Group Delay vs. Fcenter vs. Temperature

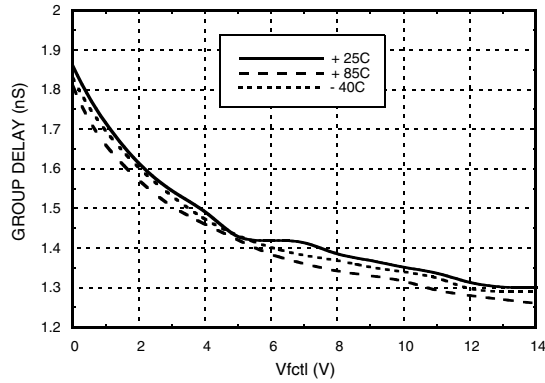

3 dB Bandwidth vs. Bandwidth Control

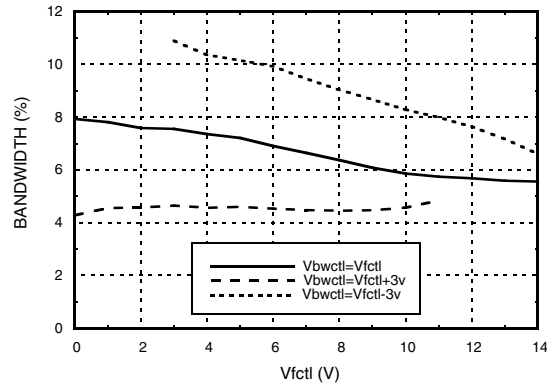

Insertion Loss vs. Bandwidth Control

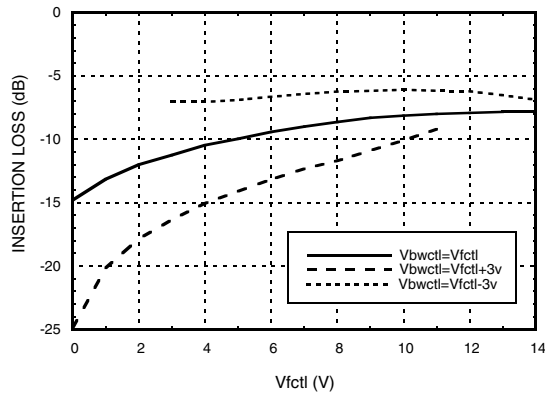

Low Side Rejection Ratio vs. Bandwidth Control [1]

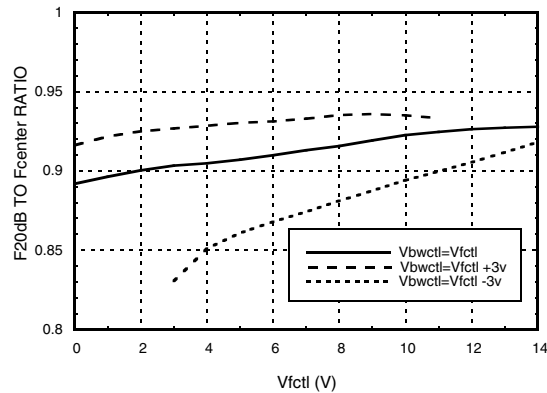

High Side Rejection Ratio vs. Bandwidth Control [1]

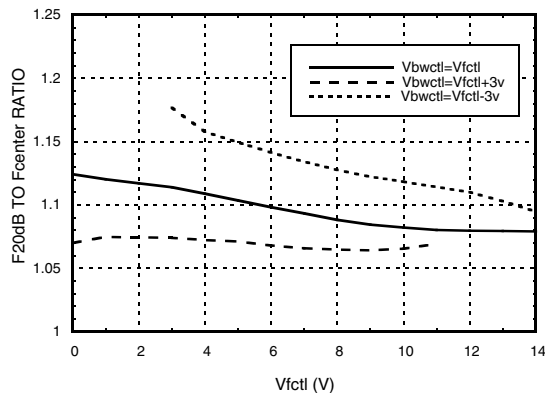

Maximum Return Loss in a 2 dB Bandwidth vs. Bandwidth Control

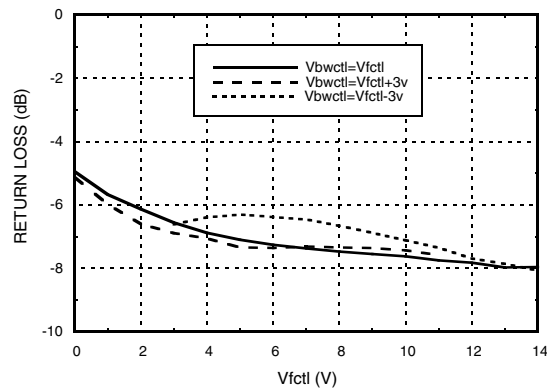

[1] Rejection ratio is defined as the ratio of the frequency at which the relative insertion loss is 20 dB to fcenter

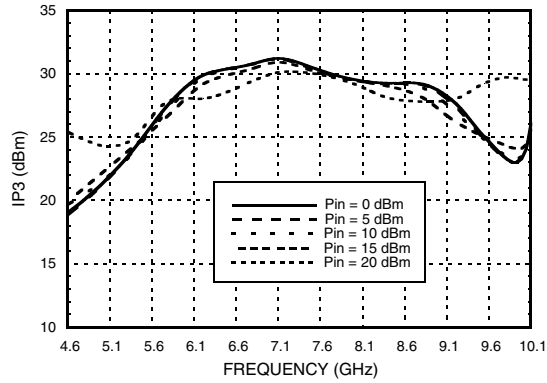
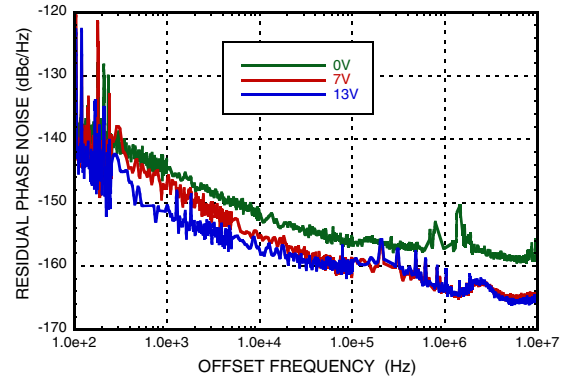
Input IP3 vs. Power Input
 $V_{fctl} = V_{bwctl}$

Residual Phase Noise
 $V_{fctl} = V_{bwctl}$

Absolute Maximum Ratings

Frequency Control Voltage (Vfctl)	-0.5 to +15V
Bandwidth Control Voltage (Vbwctl)	-0.5 to +15V
RF Power Input	26 dBm
Storage Temperature	-65 to +150 °C
ESD Rating (HBM)	Class 1B

Reliability Information

Junction Temperature to Maintain 1 Million Hour MTTF	150 °C
Nominal Junction Temperature (T= 85 °C and Pin = 10 dBm)	90 °C
Operating Temperature	-40 to +85 °C

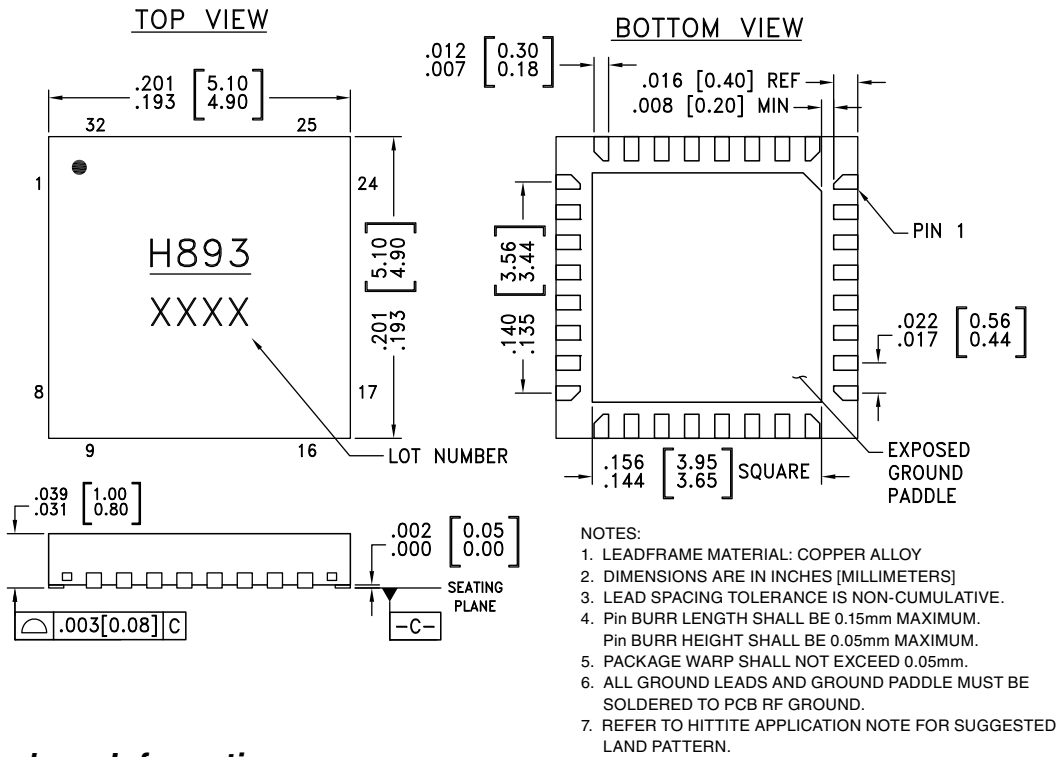

ELECTROSTATIC SENSITIVE DEVICE
OBSERVE HANDLING PRECAUTIONS

Outline Drawing

Package Information

Part Number	Package Body Material	Lead Finish	MSL Rating	Package Marking ^[1]
HMC893LP5E	RoHS-compliant Low Stress Injection Molded Plastic	100% matte Sn	MSL1 ^[2]	H893 XXXX

[1] 4-Digit lot number XXXX

[2] Max peak reflow temperature of 260 °C



Pin Descriptions

Pin Number	Function	Description	Interface Schematic
1 - 4, 7 - 11, 13 15 - 18, 21 - 32	N/C	The pins are not connected internally; however, all data shown herein was measured with these pins connected to RF/DC ground externally.	
5, 20	GND	These pins and exposed paddle must be connected to RF/DC ground.	
6	RFIN	This pin is DC coupled and matched to 50 Ohms. External voltage must not be applied to this pin.	
12	Vfctl	Center frequency control voltage.	
14	Vbwctl	Bandwidth control voltage.	
19	RFOUT	This pin is DC coupled and matched to 50 Ohms. External voltage must not be applied to this pin.	

Application Circuit

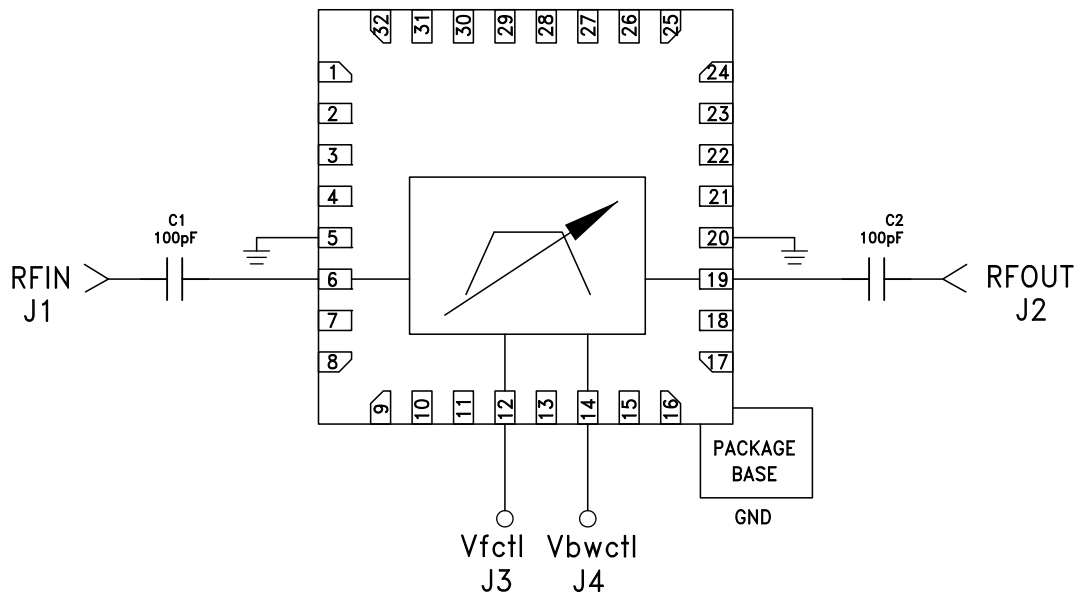

Evaluation PCB

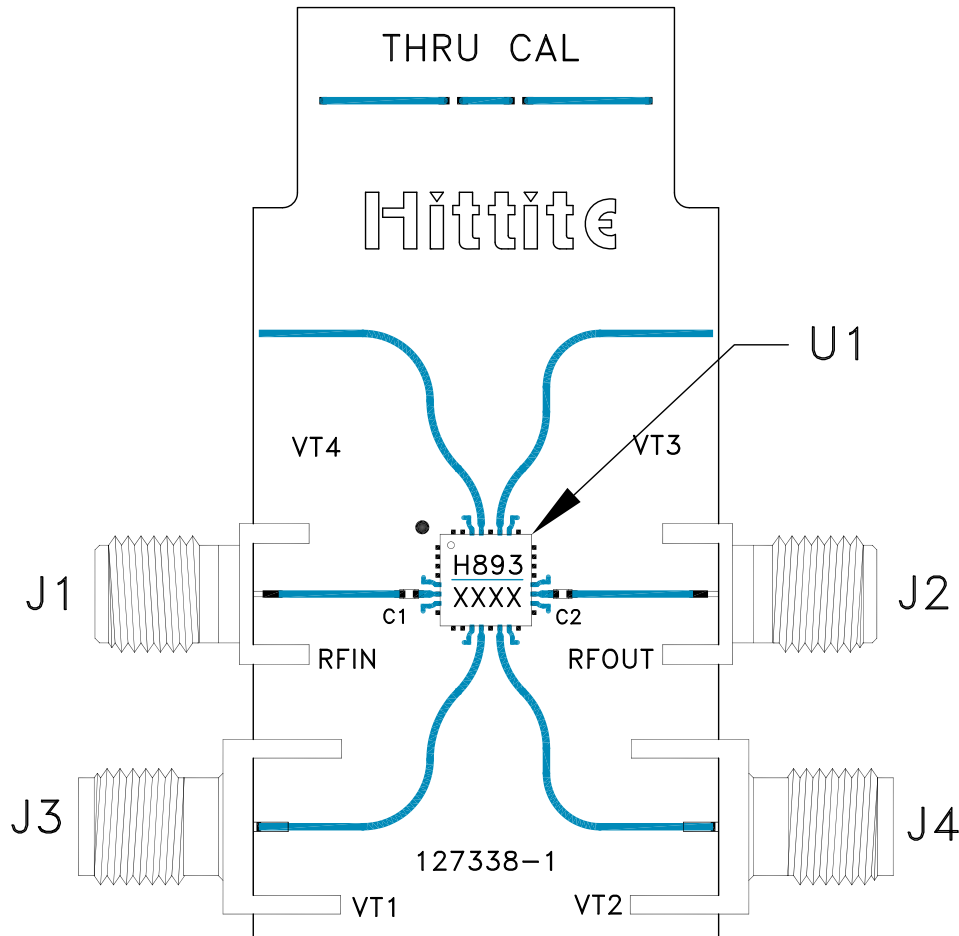

List of Materials for Evaluation PCB 128531 [1]

Item	Description
J1, J2	SMA - SRI
J3, J4	SMA - Johnson
C1, C2	100 pF Capacitor, 0402 Pkg.
U1	HMC893LP5E Filter - Tunable
PCB [2]	127338 Evaluation PCB

[1] Reference this number when ordering complete evaluation PCB

[2] Circuit Board Material: Arlon 25FR or Rogers 4350

The circuit board used in the application should use RF circuit design techniques. Signal lines should have 50 Ohms impedance while the package ground leads and exposed paddle should be connected directly to the ground plane similar to that shown. A sufficient number of via holes should be used to connect the top and bottom ground planes. The evaluation circuit board shown is available from Hittite upon request.



Notes: